



Utilities Department

Standards for Utility Connection Greater Campus Area

The University owns and operates a utility system in the Greater Campus area under the Public Utilities Act.

The Utilities Department has been designated by the University of Alberta as the Office of Accountability for all utility matters. Utility services are provided to the University of Alberta, the University of Alberta Hospital, the Cross Cancer Institute, the Jubilee Auditorium, and other smaller customers in the Greater Campus area.

Approval must be obtained from the Utilities Department for any addition, deletion, change or new installation of utility services. All costs incurred in providing the utility services must be paid for by the project.

Attached are the standards to be used for the mechanical, electrical and structural works that interface with the utility infrastructure. All these standards must be followed, unless an approved variance has been obtained.

The request for any variance from the standard must be filed with sufficient time for a proper evaluation by Utilities. If the requester is not satisfied with the decision from Utilities, the matter can be appealed to the Vice-President, Facilities & Operations.

The variance request must be in the form of a written document that addresses the following issues: reliability, safety, operability, maintainability, pricing/life cycle costing. Data and references must be submitted to support the variance request.

The liabilities that could accrue to the University for failure of utility services because of non-compliant equipment are very large. As such compliance with the standards, as outlined above, is mandatory.

Standards for Utility Connections

A. Utility Supply to Projects

- 1) The following utilities to projects are supplied from the utility corridor system:
 - a) Steam @ 1035 kPa and 205°C to 215°C
 - b) Compressed air @ 672 kPa
 - c) Demineralized water @ 550 kPa (where available)
 - d) Domestic water @ 340 to 450 kPa
 - e) Natural gas @ 96.5 kPa
 - f) Fire water @ 340 to 450 kPa
 - g) Condensate Returns @ 200 kPa and 67°C
 - h) Chilled water supply from corridor to Chilled Water bridge @ 690 kPa and 5°C.
PLEASE NOTE: Supply on the project side of the chilled water bridge will vary from 5 to 9 degrees C depending on project load and return temperature from project coils.
 - i) Chilled water returned to the Chilled Water Plant @ 655 kPa and a return temperature of no less than 13°C.
 - j) High voltage electrical power at 13.8 KV.
 - k) Communications and computer cabling
- 2) Project designers/consultants shall provide building loads to Utilities for steam, chilled water, demineralized water, domestic water, fire water, compressed air and electrical power. Utilities in turn will supply these utilities to the project perimeter.
- 3) The structure joining the utility corridor to the project shall be designed by the building designer/consultant in concert with the Utilities Department.
- 4) All structures joining the utility corridor to the project shall provide reasonable man access to the project from the utility corridor.
- 5) All piping and metering of services from the corridor to the project shall be done by the Utilities Department. Stub-ins of each service shall be provided at the project perimeter at a location mutually agreed to between Utilities and the project designer/consultant.
- 6) The project designer/consultant shall involve the Utilities Department in the very early stages of planning a building.
- 7) The cost of the structure joining the utility corridor to the project including all the services provided in the structure shall be included as part of the project cost.
- 8) The structure joining the utility corridor to the project shall be included in the project structural contract and installed by the structural contractor. The utility service lines

shall be designed, supplied and installed up to the perimeter by the Utilities Department.

- 9) Electrical power shall be supplied at 13.8 kV from a Sectionalizing Station via 3 conductor - #2/0 AWG, 15 kV teck cable. A 3/0 ground wire shall also be included and be installed from the corridor ground into the project. Project designer/consultants shall provide project loads and establish the size of the transformers. Transformers shall be of the cast coil design. Dual primary services, two full sized transformers and two primary feeders, are recommended for critical building loads. Selective primary services, one transformer and two primary feeders are recommended for general service requirements. All primary switches shall be of the compact, epoxy encased and sealed, double break interrupter design with an internal ground switch. All costs associated with providing electrical services to the project shall be part of the project cost.
- 10) The design, supply and installation of high voltage, low voltage and communications cable trays from the corridor into projects shall be included as deemed necessary for the project.

B. Storm and Sanitary Sewer Services

- 1) The project designer/consultant in conjunction with the Utilities Department will determine the locations of both sanitary and storm sewer services tie-ins.
- 2) All sanitary and storm tie-in lines and methods shall be approved by the Utilities Department.
- 3) All new project sanitary and storm services shall tie to existing systems using manholes.
- 4) The following approved sketches are included for manhole construction.
 - a) Typical Drop Manhole
 - b) Typical C.B. Manhole
 - c) Typical Standard Manhole
 - d) Typical Precast Catch Basin
 - e) Notes on Manholes

C. Fire Hydrant and Valve Installations

- 1) Fire hydrants shall be CANADA VALVE CENTURY only.
- 2) All valves shall be Mueller resilient wedge gate Model A-2360.
- 3) Valve box shall be Type “B” (screw type) c/w extension rod. See sketches for typical valve detail and installation detail for valves 100 mm to 460 mm.
- 4) For valves 50 mm and under, valve boxes are to be corrosion resistant. See sketch for typical valve details.

D. Off-Campus Utilities to Projects

- 1) Utilities to all off-campus projects shall be coordinated and supervised by the Utilities Department.
- 2) Off-campus utilities may include natural gas, domestic water, sanitary sewer, storm sewer and electrical power.
- 3) The project designer/consultant shall involve the Utilities Department in the early stage of off-campus project planning.

D. Buried Utility Systems

- 1) Where buried utility systems are approved for use, the design of the chase and of the contained pipes shall be approved by Utilities.
- 2) All piping in approved buried systems shall be insulated using Gilsulate as per manufacturers' specifications.

100 or 150 NECK RINGS

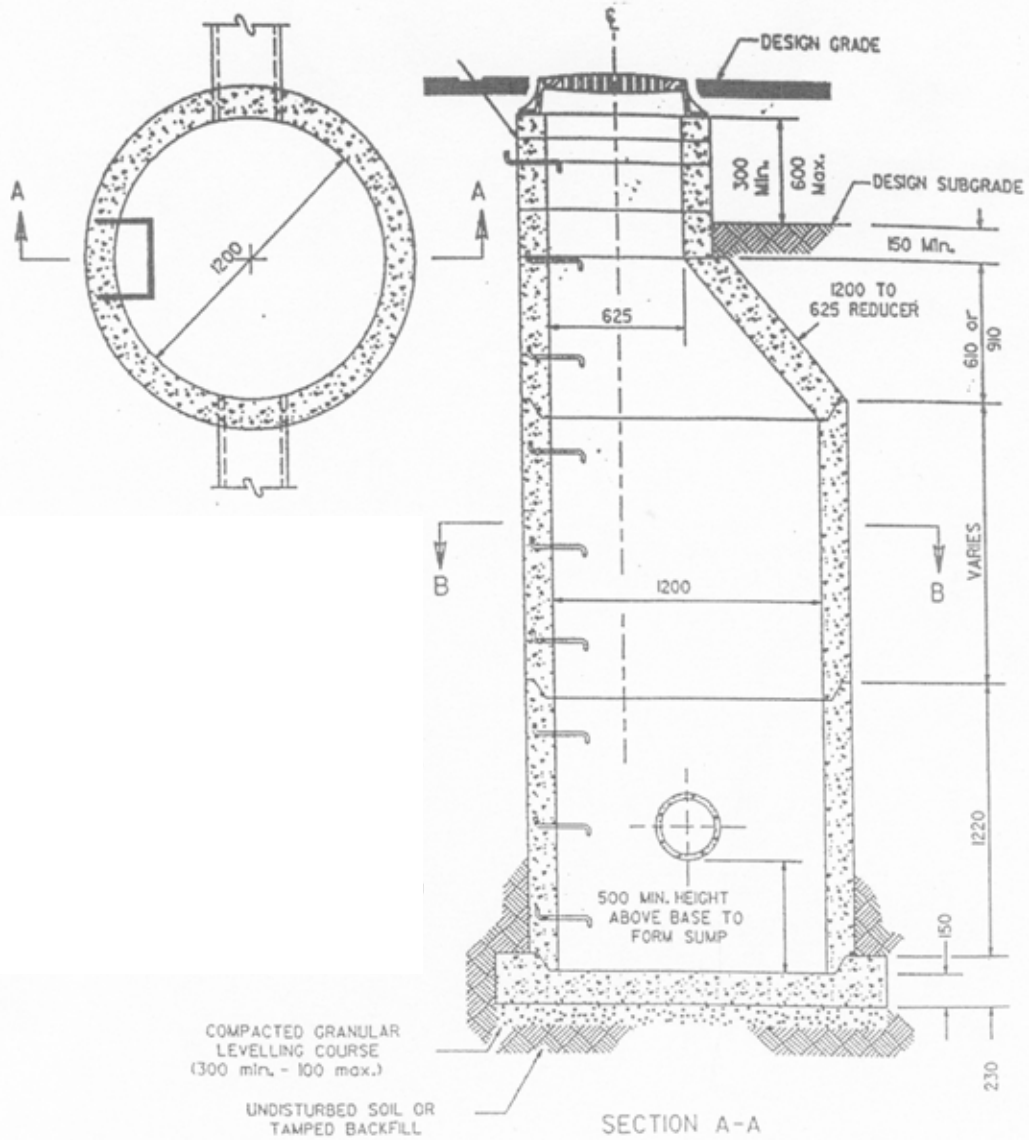

NOTES:

1. All dimensions are in millimeters unless otherwise specified.

STANDARD 1200mm C.B. MANHOLE

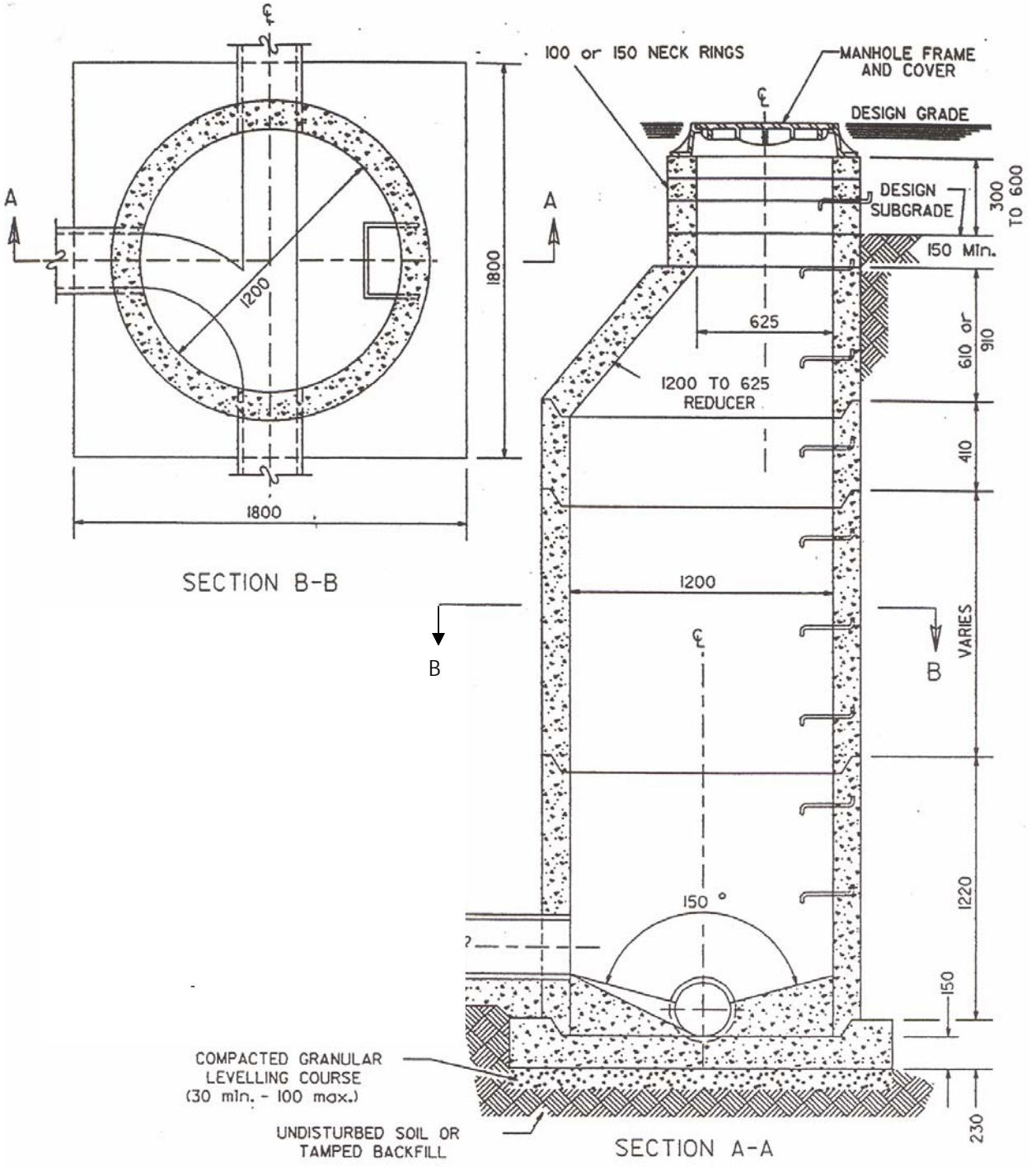

NOTES:
 1. All dimensions are in millimeters unless otherwise specified.

STANDARD 1200mm MANHOLE

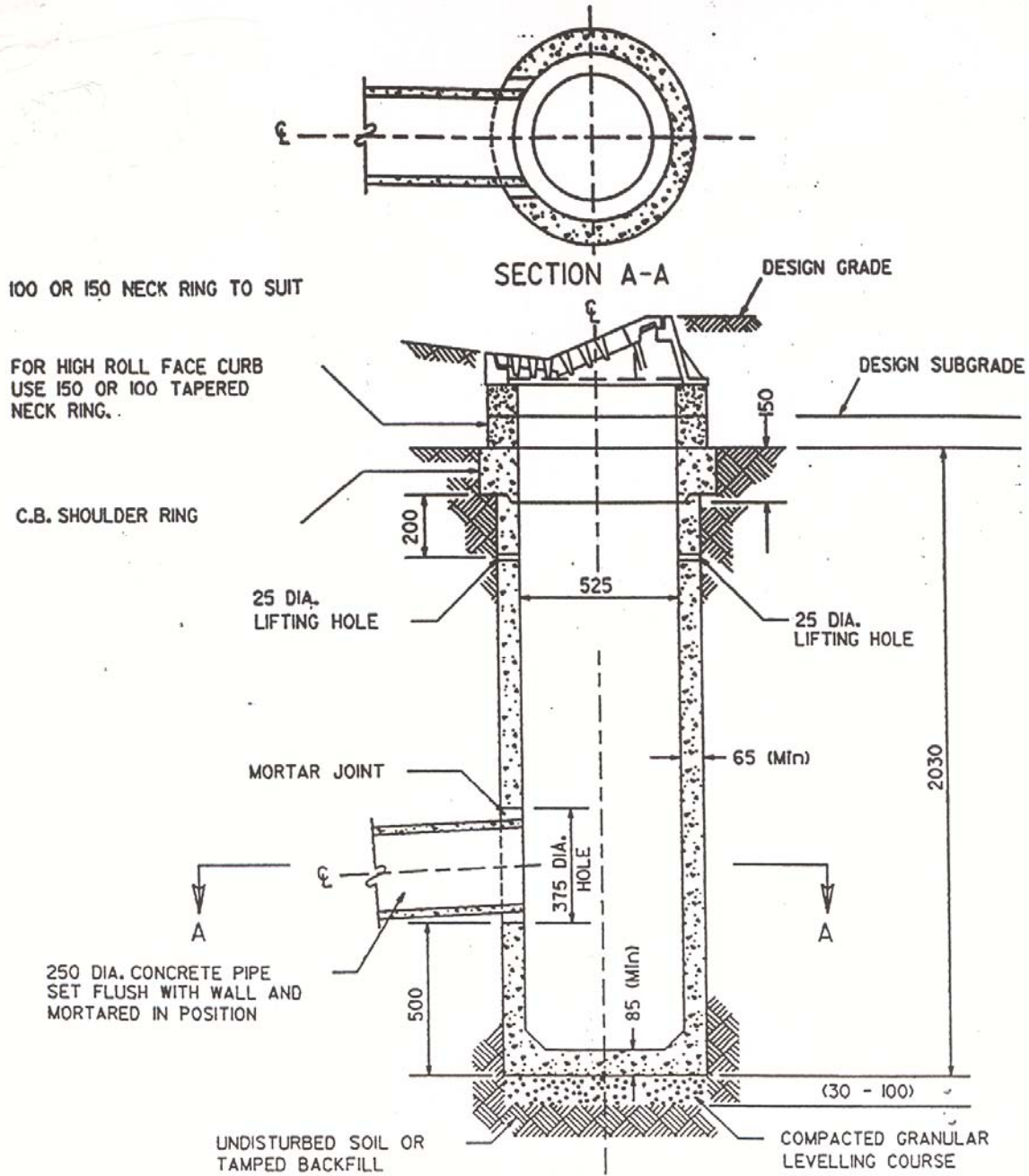

NOTES:

1. Rubber gasket, Kent seal or equivalent to be installed between barrel, all shoulder and neck rings and catch basin frame.
2. All rough joints shall be pointed with mortar to ensure smoothness.
3. All catch basin components to be in accordance with ASTM C478.

NOTE: All dimensions are in millimeters unless otherwise specified.

PRECAST CATCH BASIN

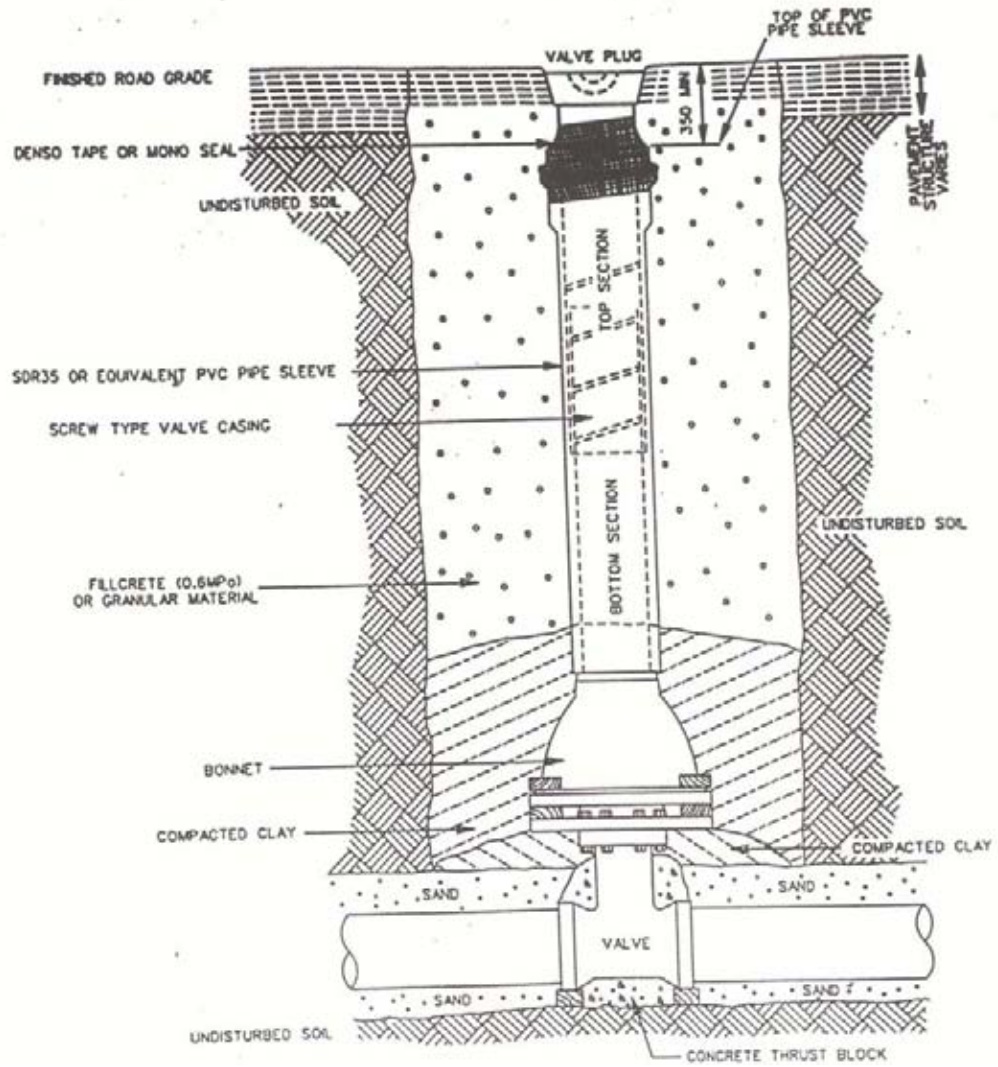

NOTES:

1. All dimensions are in millimeters unless otherwise specified.

VALVE CASING DETAIL FOR FILLCRETE AND GRANULAR MATERIAL

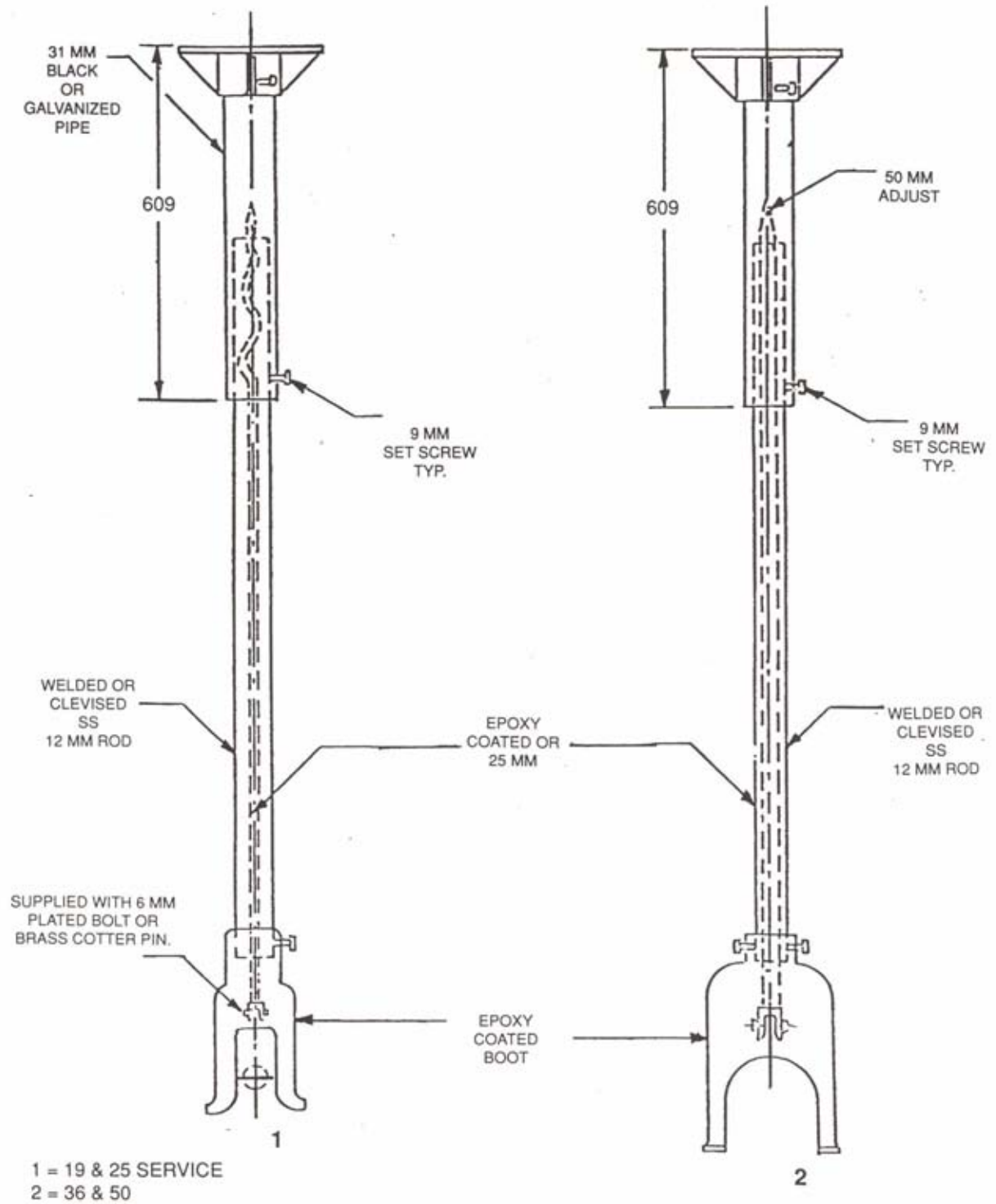

CORROSION RESISTANT SERVICE BOX

Measurements are in millimeters

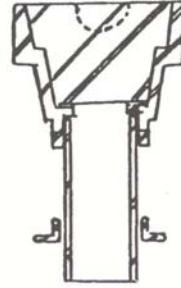
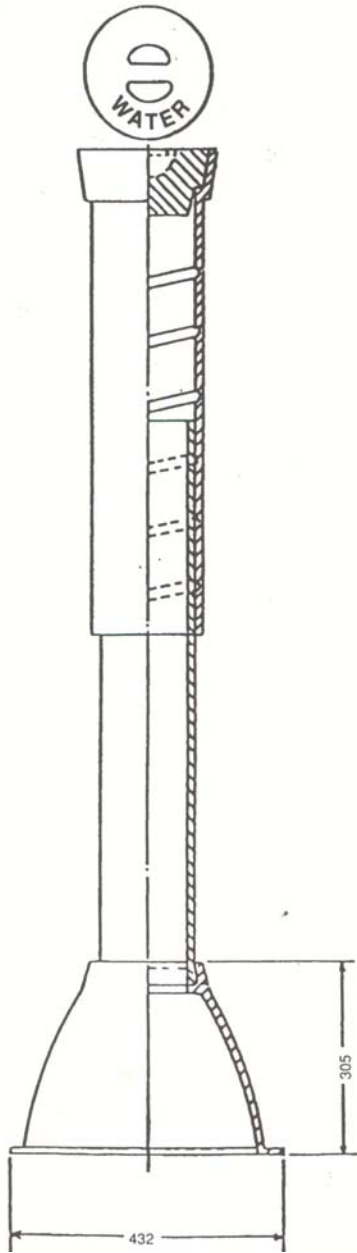

EXTENSION

NOTES

- CAN BE USED ON VALVES FROM 100 TO 460 mm

LARGE VALVE BOX
TYPE "B" Screw Type

NOTES:

1. Manhole pre-cast units to meet A.S.T.M. C478.
2. Poured in place concrete bases may be used for manholes over 5.0 m deep poured in place or pre-cast bases shall be reinforced with minimum steel area of 2.5 cm²/meter in both directions.
3. Poured in place concrete to be 20 MPa at 28 days.
4. Inlet and outlet pipes to be grouted flush with wall.
5. Safety steps required to full height of manhole.
6. Where possible, steps to be positioned to face oncoming traffic.
7. Rubber gasket, Kent seal or equivalent to be installed between pre-cast bases, pre-cast barrels all neck rings, the cone and frame cover.
8. Pipe & fittings to be PVC (Polyvinyl chloride) conforming to the following specifications.
 - 200 to 375 – A.S.T.M. D3034
 - 600 - A.S.T.M. D679

All joints to meet requirements of A.S.T.M. D3212 specifications for joints for drain and sewer plastic pipes using flexible elastomeric seals.